

JGP-503 CONVENTIONAL SPRAY GUN JGPV-503 HVLP SPRAY GUN

IMPORTANT: Before using this equipment, read all safety precautions and instructions. Keep for future use.

DESCRIPTION

Models JGP and JGPV are lightweight, high production spray guns. JGP models are conventional air spray, and JGPV are high volume, low pressure (HVLP). The gun bodies are constructed of very durable, solvent resistant Vertron® (filled nylon). Fluid passages are constructed of 300 grade stainless steel. Fluid tips and needles are also 300 grade stainless, and the fluid tip includes the "soft seat" UHMW polyethylene insert, for longer service life.

Note

These guns may be used with chlorinated type solvents, but refer to Page 2 for additional warnings.

Important: This gun may be used with most common coating and finishing materials. It is designed for use with mildly corrosive and non-abrasive materials. If used with other highly corrosive or abrasive materials, it must be expected that frequent and thorough cleaning will be required and the necessity for replacement of parts will be increased.

INSTALLATION

CAUTION

To avoid damage to gun body, do not overtighten air hose connection at air inlet. Use two wrenches if necessary.

Attach air hose to 1/4" NPS air inlet fitting on gun handle. The air inlet fitting includes a tapered seat and is designed for use with hose connections containing a similar seat. If using an NPT type fitting without a tapered seat, use two wrenches to tighten. Do not overtighten. See *Caution* above.

Attach fluid hose to 3/8" NPS fluid inlet fitting on gun.

OPERATION

Note

Protective coating and rust inhibitors have been used to keep the gun in good condition prior to shipment. Before using the gun, flush it with solvent so that these materials will be removed from fluid passages.

Strain material through 60 or 90 mesh screen. Adjust fluid pressure to deliver the desired paint volume. Adjust air pressure and flow to provide a uniform dispersion of atomized paint throughout the pattern. Keep air pressure as low as possible to minimize bounce - back and overspray. Excessive fluid flow will result in heavy center spray patterns. Inadequate flows may cause the pattern to split. See "Troubleshooting", Page 6, if any problems occur.

PREVENTIVE MAINTENANCE

To clean air cap and fluid tip, brush exterior with a stiff bristle brush. If necessary to clean cap holes, use a broom straw or toothpick. Never use a wire or hard instrument. This may scratch or burr holes causing a distorted spray pattern.

To clean fluid passages, remove excess material at source, then flush with a suitable solvent using a device such as the SolventSaver™ (see Accessories). Wipe gun exterior with a solvent dampened cloth. Never completely immerse in solvent as this is detrimental to the lubricants and packings.

Note

When replacing the fluid tip or fluid needle, replace both at the same time. Using worn parts can cause fluid leakage. See Chart 2. Also, replace the needle packing at this time. Lightly lubricate the threads of the fluid tip before reassembling. Torque to 20-25 ft. lbs. Do not overtighten the fluid tip.

CAUTION

To prevent damage to the fluid tip (3) or fluid needle (26), be sure to either 1) pull the trigger and hold while tightening or loosening the fluid tip or 2) remove fluid needle adjusting screw (21) to relieve spring pressure against needle collar.

SPRAY GUN LUBRICATION

Daily, apply a drop of SSL-10 spray gun lube at trigger bearing stud (16) and the stem of the air valve (8) where it enters the air valve assembly (12). The shank of the fluid needle (26) where it enters the packing nut (14) should also be oiled. The fluid needle packing (13) should be lubricated periodically. Make sure the baffle (5) and retaining ring (1) threads are clean and free of foreign matter. Before assembling retaining ring to baffle, clean the threads thoroughly, then add two drops of SSL-10 spray gun lube to threads. The fluid needle spring (23) and air valve spring (7) should be coated with a light grease, making sure that any excess grease will not clog the air passages. For best results, lubricate the points indicated, daily.

- A. Trigger Points
- B. Packing
- C. Adjusting Valves
- D. Baffle Threads
- E. Air Valve Cartridge

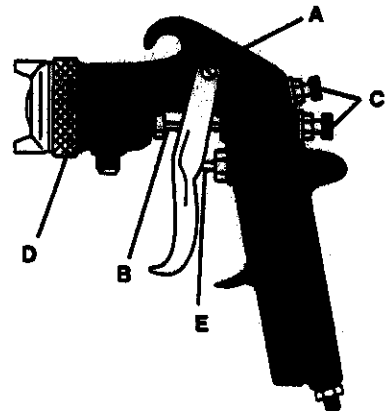

SAFETY PRECAUTIONS

This manual contains information that is important for you to know and understand. This information relates to **USER SAFETY** and **PREVENTING EQUIPMENT PROBLEMS**. To help you recognize this information, we use the following symbols. Please pay particular attention to these sections.



Important safety information - A hazard that may cause serious injury or loss of life.



Important information that tells how to prevent damage to equipment, or how to avoid a situation that may cause minor injury.

Note

Information that you should pay special attention to.



The following hazards may occur during the normal use of this equipment. Please read the following chart before using this equipment.





HAZARD	CAUSE	SAFEGUARDS
Fire 	Solvent and coatings can be highly flammable or combustible especially when sprayed.	Adequate exhaust must be provided to keep air free of accumulations of flammable vapors. Smoking must never be allowed in the spray area. Fire extinguishing equipment must be present in the spray area.
Solvent Spray 	During use and while cleaning and flushing, solvents can be forcefully expelled from fluid and air passages. Some solvents can cause eye injury.	Wear eye protection.
Inhaling Toxic Substances 	Certain materials may be harmful if inhaled, or if there is contact with the skin.	Follow the requirements of the Material Safety Data Sheet supplied by your coating material manufacturer. Adequate exhaust must be provided to keep the air free of accumulations of toxic materials. Use a mask or respirator whenever there is a chance of inhaling sprayed materials. The mask must be compatible with the material being sprayed and its concentration. Equipment must be as prescribed by an industrial hygienist or safety expert, and be NIOSH approved.
Explosion Hazard - Incompatible Materials 	Halogenated hydrocarbon solvents - for example; methylene chloride and 1, 1, 1 - Trichloroethylene are not chemically compatible with the aluminum that might be used in many system components. The chemical reaction caused by these solvents reacting with aluminum can become violent and lead to an equipment explosion.	Guns with stainless steel internal passageways may be used with these solvents. However, aluminum is widely used in other spray application equipment - such as material pumps, regulators, valves and cups. Check all equipment items before use and make sure they can also be used safely with these solvents. Read the label or data sheet for the material you intend to spray. If in doubt as to whether or not a coating or cleaning material is compatible, contact your material supplier.
General Safety	Improper operation or maintenance of equipment.	Operators should be given adequate training in the safe use & maintenance of the equipment (in accordance with the requirements of NFPA-33, Chapter 15). Users must comply with all local & national codes of practice & insurance company requirements governing ventilation, fire precautions, operation, maintenance and housekeeping. These are OSHA Sections 1910.94 and 1910.107 and NFPA-33.
Cumulative Trauma Disorders ("CTD's") CTD's, or musculo-skeletal disorders, involve damage to the hands, wrist, elbows, shoulders, neck & back. Carpal tunnel syndrome & tendinitis (such as tennis elbow or rotator cuff syndrome) are examples of CTD's.	Use of hand tools may cause cumulative trauma disorders ("CTD's"). CTD's when using hand tools, tend to affect the upper extremities. Factors which may increase the risk of developing a CTD include: 1. High frequency of the activity. 2. Excessive force, such as gripping, pinching, or pressing with the hands and fingers. 3. Extreme or awkward finger, wrist, or arm positions. 4. Excessive duration of the activity. 5. Tool vibration. 6. Repeated pressure on a body part. 7. Working in cold temperatures. CTD's can also be caused by such activities as sewing, golf, tennis, bowling, to name a few.	Pain, tingling, or numbness in the shoulder, forearm, wrist, hands or fingers, especially during the night, may be early symptoms of a CTD. Do not ignore them. Should you experience any such symptoms, see a physician immediately. Other early symptoms may include vague discomfort in the hand, loss of manual dexterity, and nonspecific pain in the arm. Ignoring early symptoms and continued repetitive use of the arm, wrist & hand can lead to serious disability. Risk is reduced by avoiding or lessening factors 1-7.

CHART 1 AIR CAP

Conventional - JGP		HVLP - JGPV	
No. on cap	Part No.	No. on cap	Part No.
704	AV-1239-704	46MP	JGHV-101-46MP
765	AV-1239-765		
777	31767-777		
797	AV-1239-797		

CHART 2 FLUID TIP AND NEEDLE (300 S.S./Poly)

•Fluid Tip ID In./mm	No. on Fluid Tip →	Order Part No.	Use With Gun
.055 (1.4)	AV-4915-FF	JGA-4056-FF	JGP Conventional
.042 (1.1)	AV-4915-FX	JGA-4056-FX	JGP Conventional
.055 (1.4)	AV-4920-FF	JGA-4051-FF	JGPV HVLP
.042 (1.1)	AV-4920-FX	JGA-4051-FX	JGPV HVLP

•AV-1 copper gasket included with fluid tip. Do not use with these guns.

PARTS LIST

Ref. No.	Replacement Part No.	Description	Individual Parts Required
1	MBC-368	Retaining Ring	1
2	See Chart 1	Air Cap	1
3	See Chart 2	Fluid Tip	1
* 4	JGD-14-K10	Gasket Kit (Kit of 10) (Polyethylene) (not used with JGPV gun)	1
5	JGD-402-1	Baffle and Gasket Kit (JGP)	1
	JGPV-401-46-50	Baffle and Gasket Kit (JGPV)	
* 6 •	JGS-72-K10	Gasket Kit (Kit of 10) (Teflon)	2
* 7	MBD-12-K25	Spring Kit (Kit of 25)	1
* 8	JGS-431-K25	Air Valve Kit (Kit of 25)	1
* 9 •	JGS-26-K25	U Cup Seal Kit (Kit of 25)	1
*10	JGA-15-K25	Washer Kit (Kit of 25)	1
*11	JGA-14-K25	Snap Ring Kit (Kit of 25)	1
12	JGS-449-1	Air Valve Assembly	1
*13•	JGV-463-K3	Packing Kit (Kit of 3)	1
14	34411-122-K10	Packing Nut Kit (Kit of 10)	1
*15	---	Screw	1
16	JGS-478	Stud & Screw Kit (Kit includes 3 studs & 5 screws)	1
17	JGS-477-1	Trigger, Stud & Screw Kit (Kit includes 1 each)	1
18	JGA-497-1	Fan Adjustment Assembly	1
*19	---	Retaining Ring	1
*20•	SSG-8069-K25	O-Ring (Viton) (Kit of 25)	1
21	JGS-16	Adjusting Screw	1
*22	---	Spring Pad (Included with # 23 and 25)	1
*23	MBD-19-K10	Spring Kit (Kit of 10)	1
24	---	Bushing	1
25	JGA-4041	Bushing, Spring Pad & Knob Kit	1
26	See Chart 2	Fluid Needle	1
27	---	Gun Body	1
#28	See Chart 2	Fluid Tip and Needle Set (Not shown)	1

- * A quantity of necessary parts is included in Major Repair Kit KK-4987-2 for complete gun repair. Keep on hand for service convenience.
- A quantity of necessary parts is included in Minor Repair Kit KK-5034 for gun repair.
- # Ref. No. 28 includes Ref. Nos. 3 & 26. AV-1 copper gasket also included but not used with JGP/JGPV guns. Suffixes - K10 designates kits of multiple parts. (Example) JGD-14-K10 is a kit of 10 gaskets.

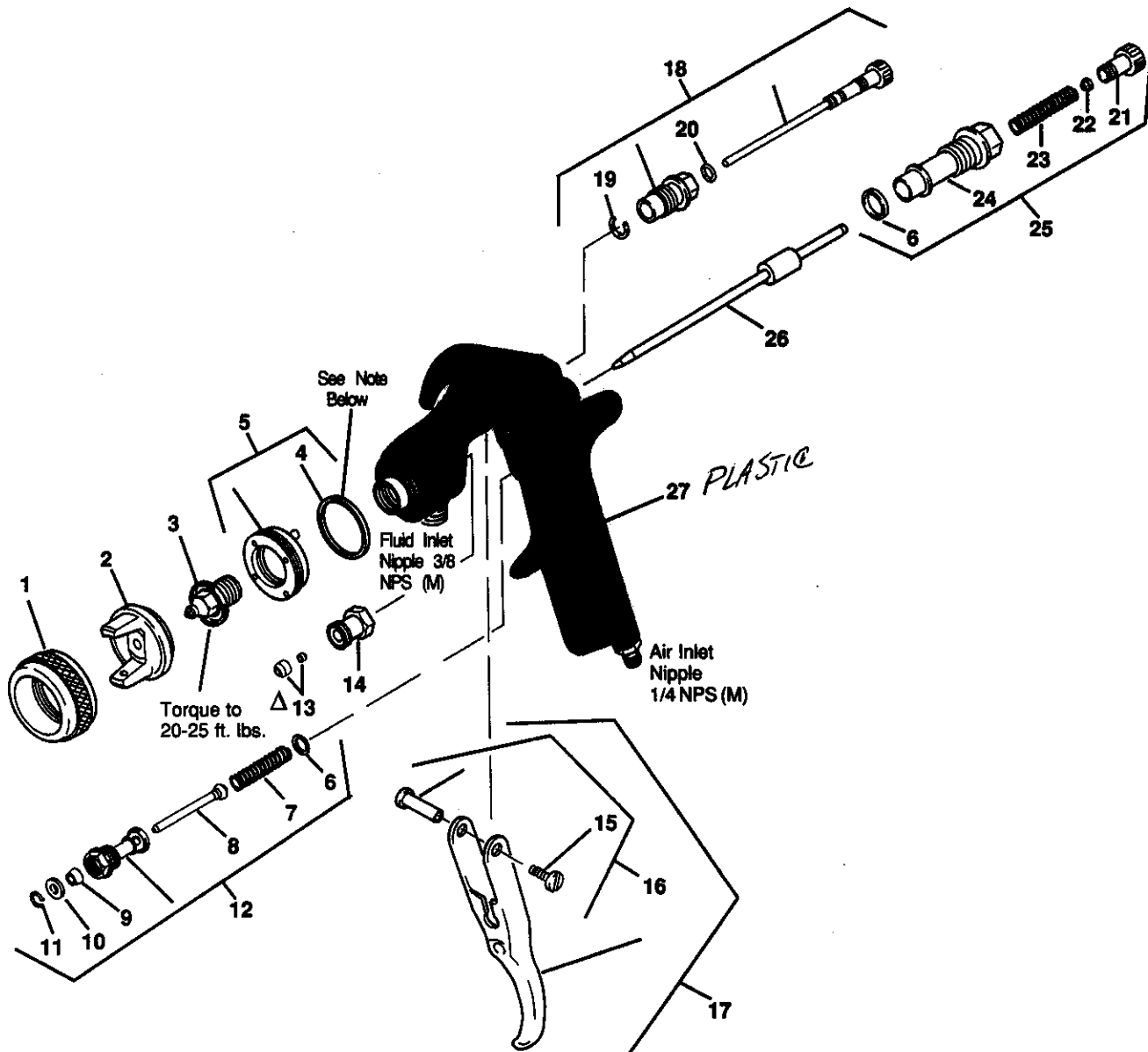

△ Detail Ref. No. 13 - Two piece packing covered by U.S. Patent No. 5,209,501.



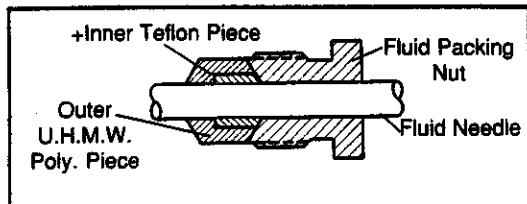

+ Tapered edge faces out towards packing nut.



Note

Gasket not used with JGPV-503 HVLP gun.

TROUBLESHOOTING

Condition	Cause	Correction
Heavy top or bottom pattern 	Horn holes plugged. Obstruction on top or bottom of fluid tip. Cap and/or tip seat dirty.	Clean. Ream with non-metallic point. Clean. Clean.
Heavy right or left side pattern 	Left or right side horn holes plugged. Dirt on left or right side of fluid tip. Remedies for the top-heavy, bottom-heavy, right-heavy and left-heavy patterns: 1) Determine if the obstruction is on the air cap or the fluid tip. Do this by making a test spray pattern. Then, rotate the cap one-half turn and spray another pattern. If the defect is inverted, obstruction is on the air cap. Clean the air cap as previously instructed. 2) If the defect is not inverted, it is on the fluid tip. Check for a fine burr on the edge of the fluid tip. Remove with #600 wet or dry sand paper. 3) Check for dried paint just inside the opening. Remove paint by washing with solvent.	Clean. Ream with non-metallic point. Clean.
Heavy center pattern 	Fluid pressure too high for atomization air (pressure feed). Material flow exceeds air cap's capacity. Spreader adjustment valve set too low. Atomizing pressure too low. Material too thick.	Balance air and fluid pressure. Increase spray pattern width with spreader adjustment valve. Thin or lower fluid flow. Adjust. Increase pressure. Thin to proper consistency.
Split spray pattern 	Atomization air pressure too high. Fluid pressure too low. Spreader adjusting valve set too high.	Reduce at transformer or gun. Increase fluid pressure (increases gun handling speed). Adjust.
Jerky or fluttering spray 	*Loose or damaged fluid tip/seat. Material level too low. Obstruction in fluid passage. Dry or loose fluid needle packing nut.	Tighten or replace. Refill. Backflush with solvent. Lubricate or tighten.
Unable to get round spray	Spreader adjustment screw not seating properly. Air cap retaining ring loose.	Clean or replace. Tighten.
Will not spray	No air pressure at gun. Fluid needle adjusting screw not open enough.	Check air supply and air lines. Open fluid needle adjusting screw.
Starved spray pattern	Inadequate material flow.	Back fluid adjusting screw out to first thread or increase fluid pressure at tank.
Excessive overspray	Too much atomization air pressure Gun too far from work surface. Improper stroking (arcing, gun motion too fast).	Reduce pressure. Adjust to proper distance. Move at moderate pace, parallel to work surface.
Excessive fog	Too much, or too fast-drying thinner. Too much atomization air pressure.	Remix properly. Reduce pressure.
Dry Spray	Air pressure too high. Gun tip too far from work surface. Gun motion too fast. Gun out of adjustment	Reduce air pressure. Adjust to proper distance. Slow down. Adjust.
Fluid leaking from packing nut	Packing nut loose. Packing worn or dry	Tighten, do not bind needle. Replace or lubricate.
Fluid leaking or dripping from front of pressure feed gun	Packing nut too tight Dry packing. Fluid tip or needle worn or damaged. Foreign matter in tip. Fluid needle spring broken. Wrong size needle or tip.	Adjust Lubricate. Replace tip & needle with lapped sets. Clean. Replace. Replace.

*Most common problem.

TROUBLESHOOTING (continued)

Condition	Cause	Correction
Runs and sags	Too much material flow. Material too thin. Gun tilted on an angle, or gun motion too slow.	Adjust gun or reduce fluid pressure. Mix properly or apply light coats. Hold gun at right angle to work and adapt to proper gun technique
Thin, sandy coarse finish drying before it flows out	Gun too far from surface. Too much air pressure. Improper thinner being used.	Check distance. Normally approx. 8". Reduce air pressure and check spray pattern. Follow paint manufacturer's mixing instructions.
Thick, dimpled finish "orange peel".	Gun too close to surface. Air pressure too low. Improper thinner being used. Material not properly mixed. Surface rough, oily, dirty.	Check distance. Normally approx. 8". Too much material coarsely atomized. Increase air pressure or reduce fluid pressure. Follow paint manufacturer's mixing instructions. Follow paint manufacturer's mixing instructions. Properly clean and prepare.

ACCESSORIES

P-H-5516 Air Adjusting Valve



Enables user to control and reduce air usage at the gun. Ideal for low pressure spraying.

42884-214-K5 3/8" 42884-215-K10 5/8" Cleaning Brushes



These brushes are helpful in cleaning threads and recesses of gun body.

HD-503 SolventSaver™ Hose/Gun Cleaner



2 Qt Hose/Gun Cleaner used to clean the inside of hose, fluid passage-ways of gun & other paint equipment.

JGA-156-K10 Spring Clip



Joins any single piece DeVilbiss air cap with latest version MBC-388 or MSA-1 retaining ring. Helps prevent parts loss and provides easier assembly.

Spray Gun Lube SSL-10 (2 oz. bottle)



Compatible with all paint materials: contains no silicone or petroleum distillates to contaminate paint.

HAV-500 OR HAV-501 Adjusting Valve (HAV-501 SHOWN)



HAV-500 does not have pressure gauge. Use to control air usage at gun.

WR-103 Wrench



Contains all necessary tip, hose and nut sizes used on or with gun.

VS-531 Low Pressure Strainers



The VS-531 Low Pressure Fluid Strainer provides a final filter for trapping foreign particles in the paint supply.

QMGZ SolventSaver™ Hose/Gun Cleaner

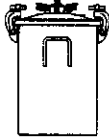

2 Gallon galvanized tank used to clean the inside of hose and material passages of the gun.

Quick Disconnect Approved for HVLP Guns (Air) High Flow Ball and Ring Type

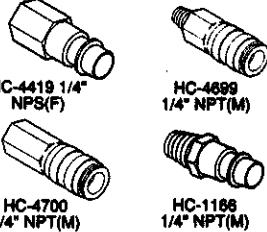

HC-4419 1/4" NPS(F) HC-4699 1/4" NPT(M)
HC-4700 1/4" NPT(M) HC-1186 1/4" NPT(M)

KB-555 (Aluminum) & KB-545-SS (S/S) 2 qt. Pressure Feed Cup With Regulator



Provides greater degree of control over cup fluid pressure.

JGA-4035-K5 (3 Piece Packing) - May be used in place of JGV-463-K3 (2 piece packing).

JGA-444 Fluid Tube - This tube combines the fluid and air hoses at gun handle preventing dragging hoses over work, twisting line and improving overall gun handling.

WARRANTY

This product is covered by DeVilbiss' 1 Year Limited Warranty. See SB-1-000 which is available upon request.

DeVilbiss Industrial Spray Equipment - DeVilbiss has authorized distributors throughout the world. If further assistance is required, write or call one of the following DeVilbiss Distribution Centers or Sales Offices nearest you. **FOR TECHNICAL ASSISTANCE OR THE DISTRIBUTOR NEAREST YOU, CALL TOLL FREE 1-800-338-4448 (U.S.A. & Canada).** **FOR LOCAL CALLS, SEE LISTING BELOW.**

U.S./Canada Sales & Customer Service Office **Address**
MAUMEE, OH 43537 1724 Indian Wood Circle

Telephone No.
(419) 891-8200
Toll Free Fax No. 1-800-338-0131

DeVilbiss Automotive Refinishing - DeVilbiss has authorized distributors throughout the world. For equipment, parts and service, check the Yellow Pages under "Automobile Body Shop Equipment and Supplies." If further assistance is required, write or call one of the following DeVilbiss Distribution Centers or Sales Offices nearest you. **FOR TECHNICAL ASSISTANCE, CALL TOLL FREE 1-800-445-3988 (U.S.A. & Canada).** **FOR LOCAL CALLS, SEE LISTING BELOW.**

U.S. Customer Service Office **Address**
Maumee, OH 43537 1724 Indian Wood Circle

Telephone No.
General Inquiry (419) 891-8100
Toll Free Fax No. 1-800-445-6643



An Illinois Tool Works Company